



LED PUCK AIR

CATENARY LIGHTING REIMAGINED

LED Puck Air is the incredibly lightweight, highly versatile, and exceptionally elegant catenary lighting system for today's modern world. High performance yet only a fraction of the size and weight of other systems, Air enables safe, reliable, clutter-free catenary and welcomes infinite design possibilities for everything from outdoor gathering spaces to indoor accent lighting.

APPLICATIONS

- Outdoor
- Indoor
- High-end Retail
- Display Case
- Art Galleries & Museums

OPTIONS & ACCESSORIES

Air comes available in a range of body and distribution types. Customise your Air with options and interchangeable accessories. See page 2 and our *Spec Your LED Puck Air Code Reference* sheets.

SPECIFICATIONS

TECHNICAL

- 8W
- CRI 80+ (CRI 90+ OPTION)
- 3 STEP MACADAM ELLIPSE
- B₅₀ L₇₀ >100,000h

PERFORMANCE

- UP TO 850 LUMENS (8W @ 4000K)
- OVER 100LM/W

OPTICS

- POLYCARBONATE / PMMA

DISTRIBUTION

- AVAILABLE IN A RANGE OF DISTRIBUTIONS:
- CIRCULAR / OVAL / DECORATIVE (SEE FOLLOWING PAGES)

MATERIAL

- MARINE GRADE ALUMINIUM (STANDARD)

FINISH

- ANODIZED BLACK MATTE (STANDARD)
- LENS RING COLOUR OPTIONS AVAILABLE

AMBIENT OPERATING CONDITIONS

- MIN. -40° / MAX. 55°

PROTECTION CLASS*

- POLYCARBONATE IP67 / IK10

ELECTRICAL

- VOLTAGE 24V

INSTALLATION

- Ø3MM TWIN CABLE SUSPENSION (SUPPLIED BY MANUFACTURER)

CONTROL

- GLOBAL: 0-10, DALI, PHASE, CASAMBI;
- INDIVIDUAL: DALI, CASAMBI

DIMENSIONS & WEIGHT

- Ø25MM X 150MM LUMINAIRE
- 100 GRAMS PER LUMINAIRE

CABLE SPECIFICATIONS

- SINGLE CORE 1.00MM² TINNED COPPER WITH KEVLAR BRAID



Air comes in Standard, Axis (Pan & Tilt), and Pendant body types.



ETLus conforms to UL2108 cETL conforms to CSA C22.2 #250.0

*Note, Zoom rated IP63

*Specifications are subject to change without notice.
planetlighting.com/led-puck ver. 03082021-00 01



BODY OPTIONS

LED PUCK AIR



Get creative with LED Puck Air's clever family of options. Choose either Standard, Axis or Pendant body type, then select your distribution. Interchangeable accessories and options are also available. See our *Air Options* and *Spec Your LED Puck Air Code Reference* for more details.

STANDARD
BODY

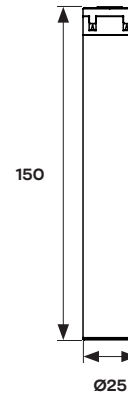
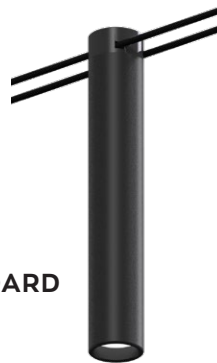

AXIS BODY
(PAN & TILT)

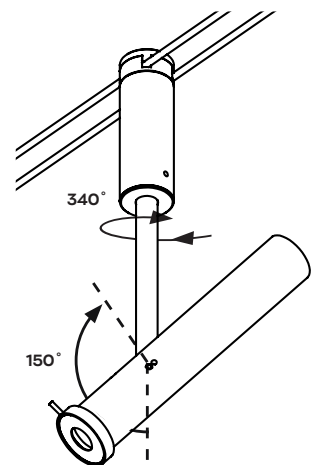

Choose Standard, Axis or Pendant body type. Final dimensions will vary depending on which options are chosen

PENDANT
BODY

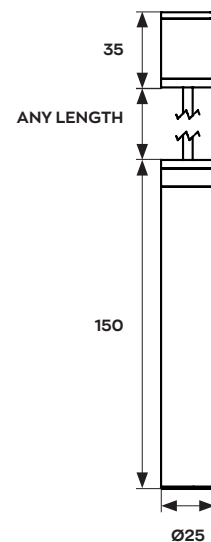

All Dimensions in millimetres (mm).

*Specifications are subject to change without notice.

planetlighting.com/led-puck ver. 03082021-00 02



DISTRIBUTION OPTIONS

LED PUCK AIR

SERIES

DISTRIBUTION

DESCRIPTION

AIR DIRECTOR

Precise, high uniformity and limitless flexibility, our Air Director series lets you sculpt with light with incredible control.

Air Shoot



Symmetrical beam with limiter producing a narrow spot with zero side spill

Air Spot



Symmetrical and precise extra narrow spot

Air Narrow



Symmetrical, precise narrow spot

Air Medium



Symmetrical, precise medium spot

Air Wide



Symmetrical wide spot

Air Oval



Wide elliptical beam

Air Square



Ultra-wide square batwing

Air Line



Ultra-wide line batwing

Air Zoom



Flexible focus beam adjustment from narrow to wide

Air Iris



Adjustable beam limiter from narrow to wide

SERIES

DISTRIBUTION

DESCRIPTION

AIR BRILLIANT

Decorative and diffuse distribution options to set the mood and ambience.

Air Diamond



Cut glass with high refractive effect producing a distinct star-shaped pattern and bright centre point

Air Prism



Cut glass with a soft but defined kaleidoscope effect

Air Wand



Modern festoon dual lighting effect

Air Globe



Modern festoon lantern. Choose from Globe Closed, Globe Open, Globe Half, Globe Silver, Globe Frosted or Globe Glass.







COLOUR OPTIONS

LED PUCK AIR

Choose your colour.

COLOUR









2700K		Tunable White [†]	
3000K		RGBW [†]	
4000K			



Engineer the experience with LED Puck Air's family of options. See our *Spec Your LED Puck Air Code Reference* sheets.

ACCESSORIES, FINISHES & EXTRA OPTIONS

Choose your finish, accessories and any additional options. LED Puck Air comes standard in anodized black marine grade aluminium with matching lens ring.

FINISH / ACCESSORY		DESCRIPTION
Black Matte Body (Standard)		Anodized standard black marine grade aluminium
Black Lens Ring Finish (Standard)		Standard black lens ring finish
Gold Lens Ring Finish		Gold lens ring finish
Silver Lens Ring Finish		Silver lens ring finish
Painted Finish		Painted finish (please specify / contact us)
CRI 90		CRI90+
Barn Doors		4 door adjustable barn doors
Air Lens Cover		Polycarbonate lens cover



MOUNTING HARDWARE SETS

LED PUCK AIR

Drawings Not to Scale

A range of mounting parts are available for catenary including Pole Mounts, Eyebolts for Timber, Masonry and Metal, and a Universal Plate Mount. Sets come complete with Mount, Turnbuckles, blocks and grub screws. Cable and Drivers are available separately.

Total Installed horizontal loading:
40-50kg tensile force



Spec Your Mounting
See our Air Catenary Mounting Reference Sheets

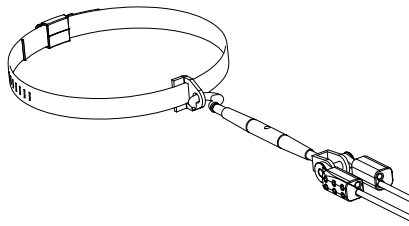

Pole (or tree) Mount

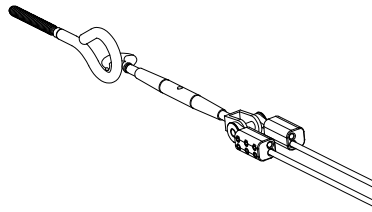

Eyebolt Mount:
Timber, Masonry, Metal

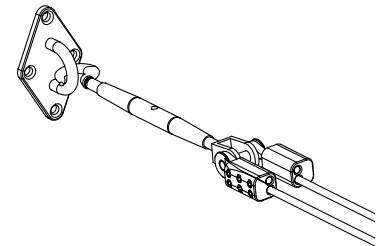

Universal Plate Mount

CONNECTION

LED Puck Air has a combined all-in-one twin cable suspension and power system, including Dim over power. There is no need for a separate power cable.

Air will conveniently mount and connect simultaneously via its screw on/off cap making repositioning simple.

instant mounting and connection via Air's screw on cap*.

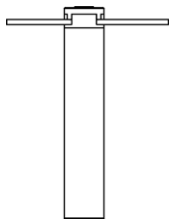

Luminaire Connected (Cap On)
Side View

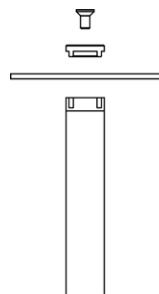

Luminaire Disconnected (Cap Off)
Side View & Isometric

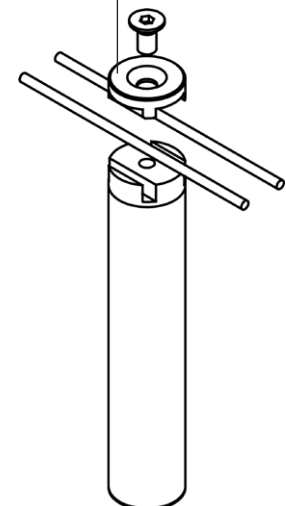

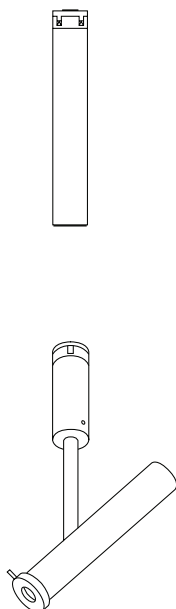
LED LED PUCK AIR, Vajersystem 8 W, CRI 80, IP67**LPA standard**

LPA Standard lins narrow	45-LPA-ST-LN-XX
LPA Standard lins medium	45-LPA-ST-LM-XX
LPA Standard lins wide	45-LPA-ST-LW-XX
LPA Standard lins oval	45-LPA-ST-LO-XX
LPA Standard Snoot spot	45-LPA-ST-SN-XX
LPA Standard Globe Closed	45-LPA-ST-GC-XX
LPA Standard Globe Open	45-LPA-ST-GO-XX
LPA Standard Globe Half-Open	45-LPA-ST-GH-XX
LPA Standard Globe Silver	45-LPA-ST-GS-XX
LPA Standard Globe Frosted	45-LPA-ST-GF-XX
LPA Standard Globe Glass	45-LPA-ST-GG-XX
LPA Standard Plastglob Ø50	45-LPA-ST-PG50-XX
LPA Standard Plastglob Ø70	45-LPA-ST-PG70-XX
LPA Standard Wand	45-LPA-ST-WA-XX
LPA Standard Diamond	45-LPA-ST-DI-XX
LPA Standard Prism	45-LPA-ST-PR-XX

LPA Axis

LPA Axis lins narrow	45-LPA-AX-LN-XX
LPA Axis lins medium	45-LPA-AX-LM-XX
LPA Axis lins wide	45-LPA-AX-LW-XX
LPA Axis lins oval	45-LPA-AX-LO-XX
LPA Axis Iris	45-LPA-AX-LO-XX

Kombinera med färgtemperatur	
27	2700 K
30	3000 K
40	4000 K
Exempel: 45-LPA-ST-LN-30	

Monteringsstillbehör och likriktare

3 mm kabel med kevlar (pris/meter)	45-AIR-CABLE
3 mm kabel med kevlar 500 m rulle	45-AIR-CABLE-500
Vantskruv inkl. 2 x kabellås	45-AIR-TB
Vantskruv med ögonbult för trä, inkl. 2 x kabellås	45-NON-TIM
Vantskruv med ögonbult för murverk, inkl. 2 x kabellås	45-NON-MMAS
Vantskruv med ögonbult för metall, inkl. 2 x kabellås	45-NON-MET
Vantskruv med fäste för stolpe (ange stolpdiameter), inkl. 2 x kabellås	45-NON-PXX
Vantskruv med universalplatta, inkl. 2 x kabellås	45-NON-PLA
Strömhub till LPA	45-AIR-HUB
Likriktare 230VAC/24VDC, 60W, IP67	80-HLG-60H-24
Likriktare 230VAC/24VDC, 100W, IP67	80-HLG-100H-24
Likriktare 230VAC/24VDC, 150W, IP67	80-HLG-150H-24
Likriktare 230VAC/24VDC, 240W, IP67	80-HLG-240H-24
Likriktare 230VAC/24VDC, 320W, IP67	80-HLG-320H-24